

SYSTEM PLUS CONSULTING

TEARDOWN TRACKS OFFER

www.reverse-costing.com

Electronic **Costing & Technology** Experts





FEATURES

- › Teardowns of phones, smart home, wearables, connected and automotive devices
- › Bill-of-Materials



DELIVERABLES

- › Web access
- › Downloadable PDF and Excel files
- › High-resolution photos

KEY ASSET

- › In-house teardowns and BoM
- › Dynamic web portal to follow the analysis progress and access it anytime



CONSUMER - 140+ per year

- Smartphones
 - 530+ products already available
 - Flagship phones
 - Feature phones
- Smart Home
 - 110+ products already available
 - Smart speakers
 - Home assistants
- Wearables
 - 160+ products already available
 - Smart watches
 - Earbuds
- Tablet, Computing & Gaming
 - 150+ products already available
 - Tablet/Hybrid, Laptop
 - Graphic Cards, Game Stations



AUTOMOTIVE - 65+ per year

- ADAS
 - Radars, cameras and LiDAR
 - Computing units
- Electrification - **NEW**
 - Inverter, BMS
 - On-Board Charger
- Infotainment
 - Cluster Display, IVI Display
 - Silver box
- Telematics
 - 3G/4G
 - GPS, WiFi and bluetooth

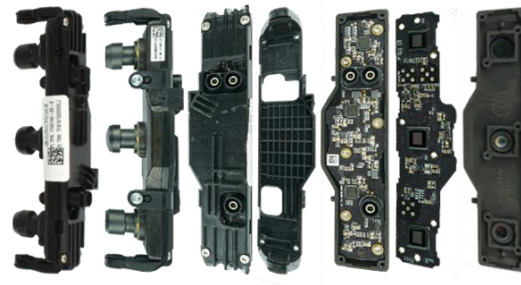

1000+ products

205+
teardowns
per year

8 tracks

14,000+
components
analysed

60,000+ high
resolution
pictures

ADAS

- Radars
- Cameras
- Ultrasonic Sensors
- LiDAR
- Central Unit

Infotainment

- Cluster Display
- IVI Display
- Silver box

Telematics

- 3G/4G
- GPS
- WiFi/Bluetooth

Electrification

(future integration)

- Inverter
- On-Board Charger
- DC-DC Converter

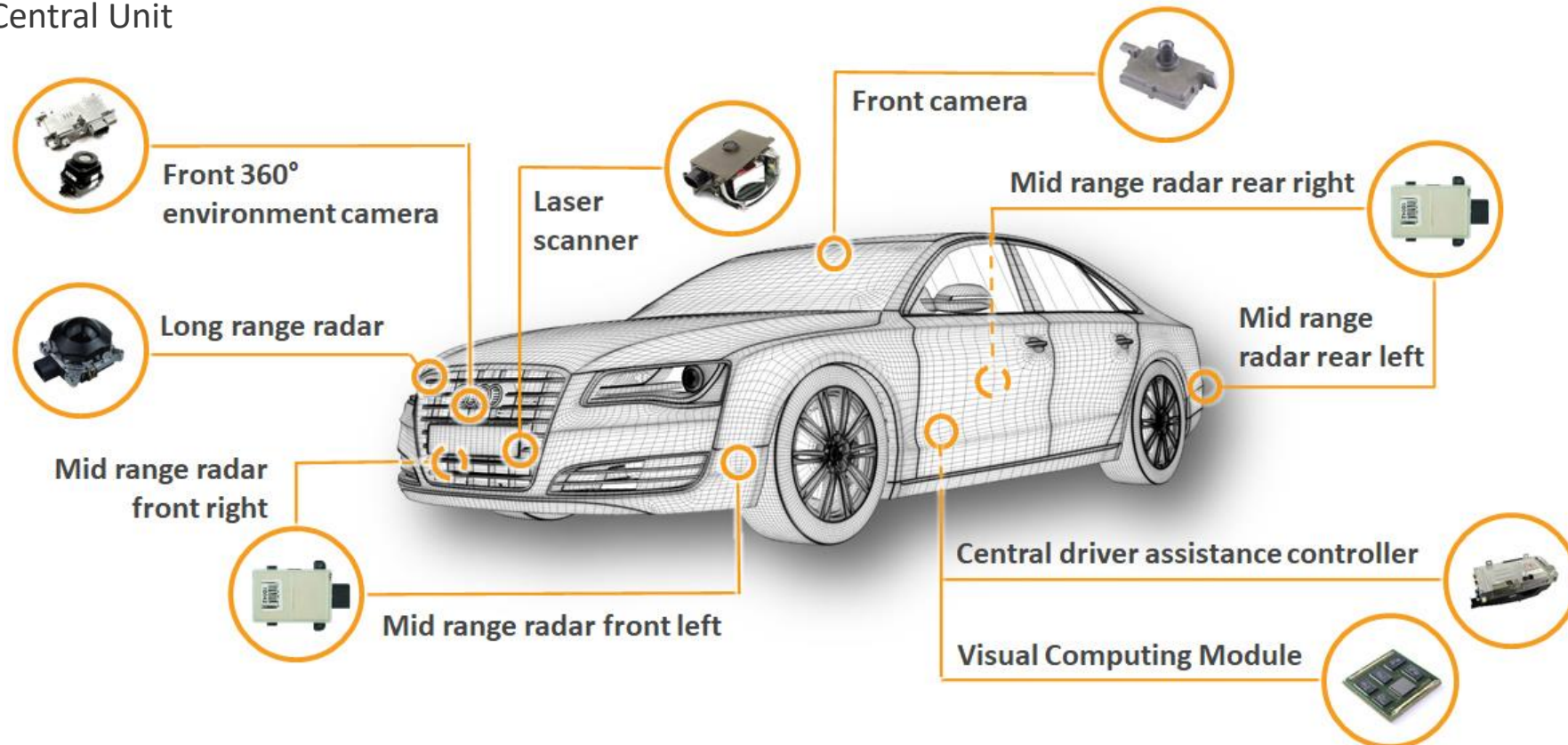

Example of Audi A8 sensors and computing analyzed by System Plus Consulting.
The tear downed cars are not analyzed entirely.

- Web-based format, in addition to PDFs download, allows access to immediate updates as our teardowns progress
- Interactive portal: www.reverse-costing.com
 - View features and specs of each device or component
 - Browse, zoom, and download imagery using our interactive tools
 - Compare products
 - Perform robust database searches on specific devices or components, and then download the sections of our teardown report that's most relevant to them
 - View detailed parts lists, BOMs, and cost summary, and then follow links to other devices employing the same component
 - Plot power measurement data across all tests for consumer products
 - Weekly updated
- All past teardowns and the next 12 months ones are available within the annual subscription



The screenshot displays the website interface for the Google Pixel 3 XL teardown. At the top, there is a navigation bar with categories like Phone, Smart Home, Wearable, Connected Devices, and Parts. Below this, the product page for the Google Pixel 3 XL is shown, including a photo of the phone and a table of specifications.

Subscription Category
Phones
Manufacturer
Google
Manufacturer Website
Date Announced
Oct. 18, 2018
Teardown Date
Nov. 9, 2018

Below the table, there are links for 'FCC Internal Reports' and 'View FCC Data', and a 'Downloads' button.

The right side of the screenshot shows a 'Board Photos' section with a large image of the phone's internal circuit board. The board is annotated with various components and their connections:

- SONY SPDT CXA4405
- To ear-piece flex
- To front camera #2
- To WiFi(2)/B46(2) antenna
- To fingerprint sensor
- MURATA WiFi/BT/FM module 1QB SS8xxxxxx
- To button flex
- 38.4MHz Xtal w/ TC cap
- CIRRUS LOGIC Audio amp CS35L36
- QCOM PMU PM845

The website URL www.reverse-costing.com is visible at the bottom of the board photo section.

Every system teardown includes:

- Detailed parts lists with fully-costed BOMs
- Highly detailed block diagrams
- High-resolution photos
- X-rays
- Detailed power measurements available for nearly every operating mode (consumer products)

Total ASP Of Manufacturer

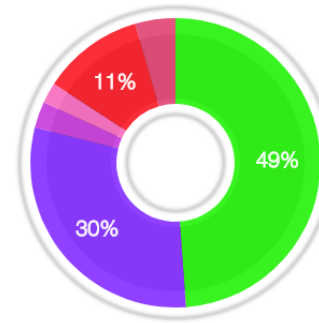

Others list: MAXIM IDT CIRRUS LOGIC SAMSUNG
NXP FAIRCHILD PERICOM EPCOS SONY QORVO

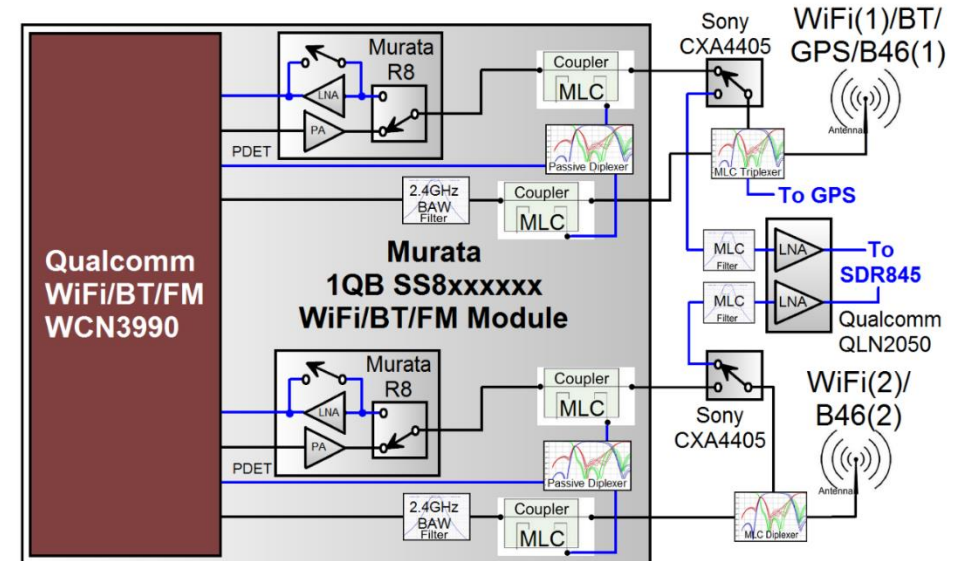
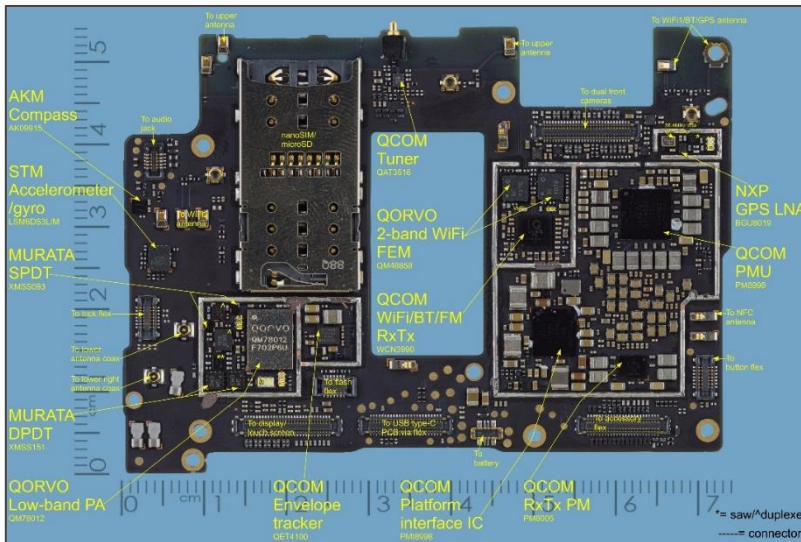
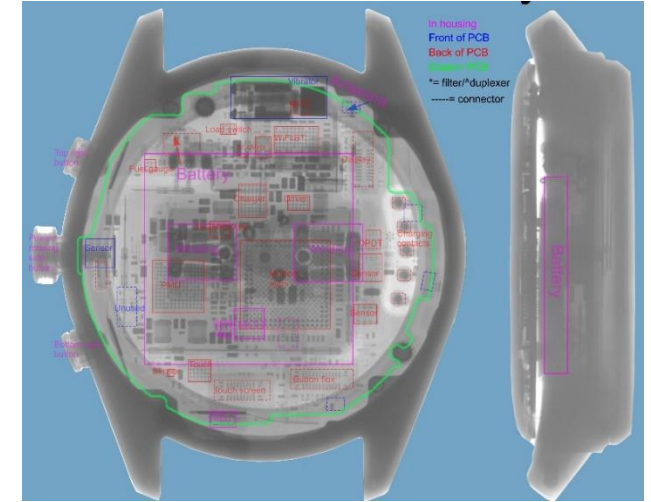

Every product teardown includes:

- Sub-Teardown of each component with greater than 6-pin
- Robust database searches

Component already included in:

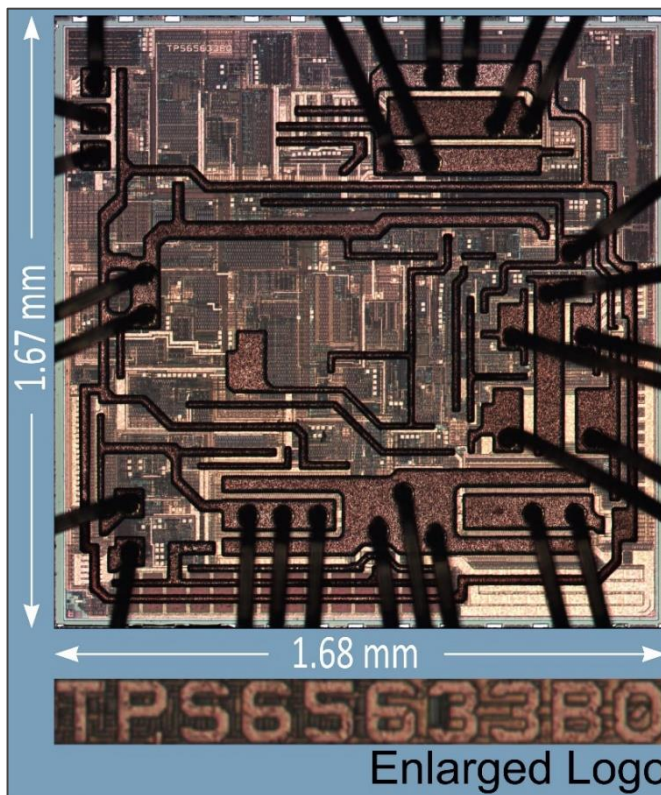
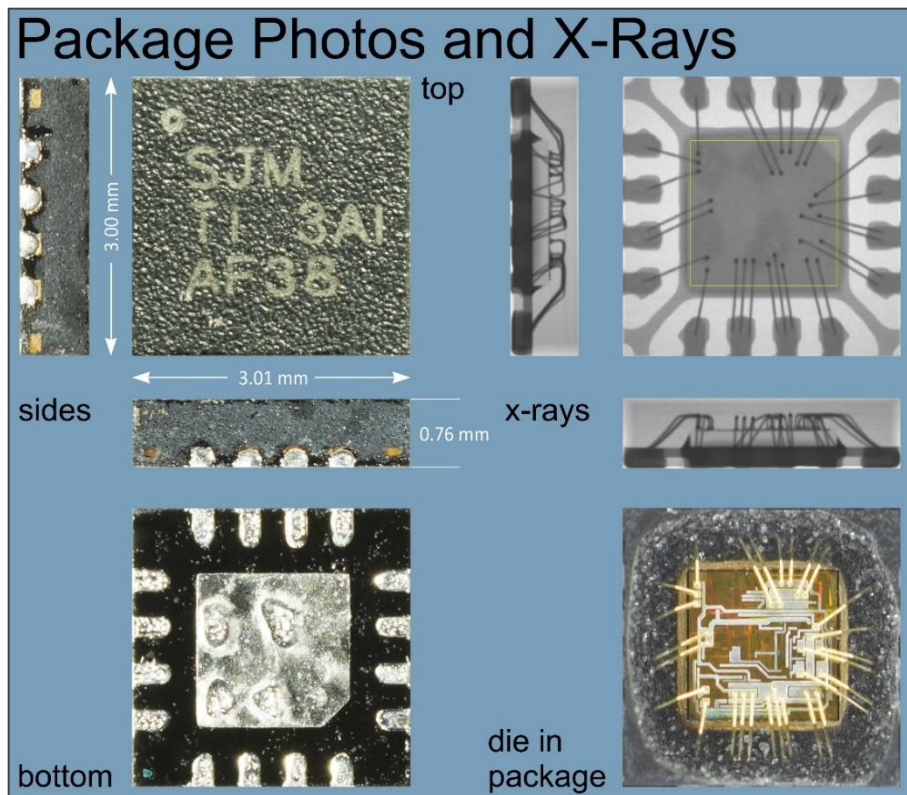

Motorola Moto X (2nd Gen)
Yota Devices YotaPhone 2
Xiaomi Tech Mi 8 Explorer Edition
OPPO R17 PRO
Meizu Pro 7 Plus
Dell Venue 8
Motorola Nexus 6
Gionee M7
Google Pixel 2
OPPO R11
Google Pixel
OnePlus 6
Vivo NEX S
Samsung Galaxy Note 3 ATT
Motorola Droid Turbo
Samsung Galaxy S5 k zoom
Xiaomi Tech Mi 8
Motorola MotoZ
Yota Devices Yota3

High resolution photos at every step

- Highest-resolution photos of anyone in the industry
- 33% more information provided through angled views, side and top x-rays, and high-resolution zooming

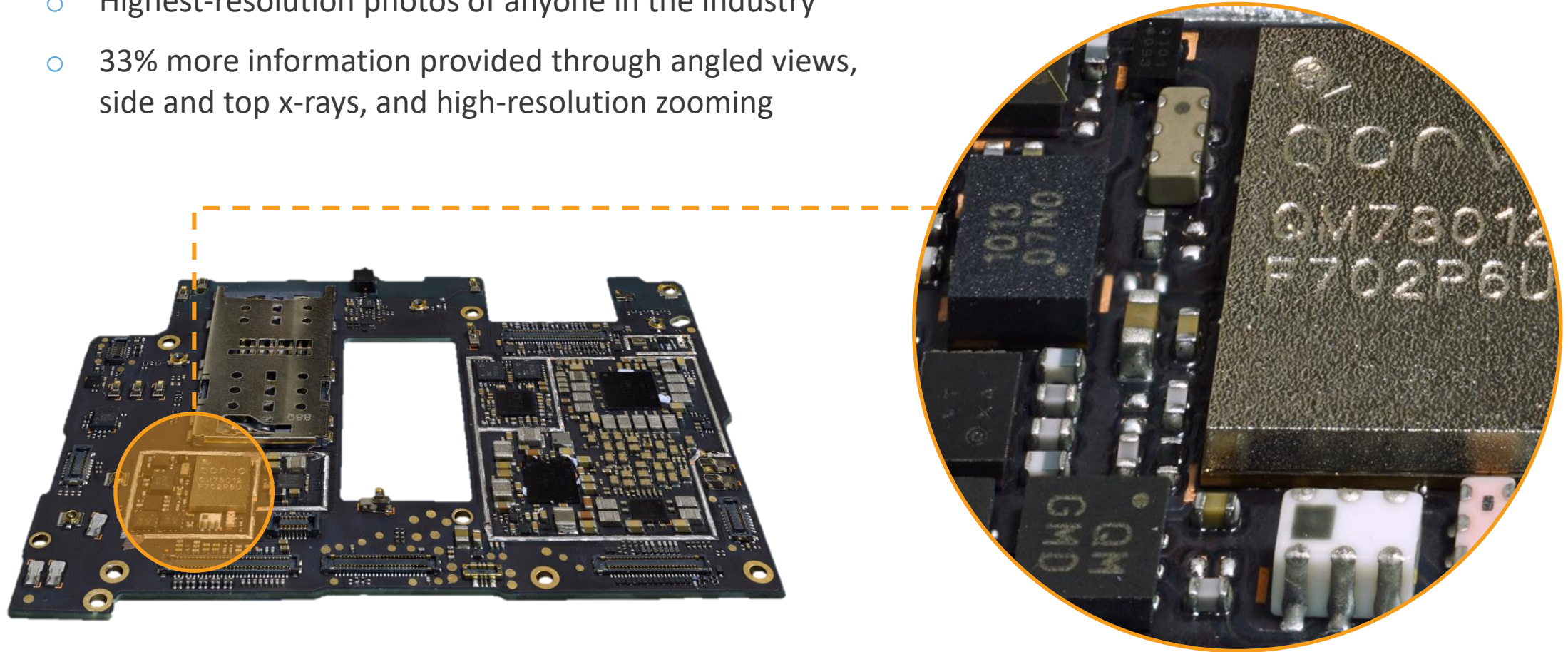

REPORTS, MONITORS & TRACKS

Western US & Canada

Steve Laferriere - steve.laferriere@yole.fr
+ 1 310 600 8267

Eastern US & Canada

Chris Youman - chris.youman@yole.fr
+1 919 607 9839

Europe and RoW

Lizzie Levenez - lizzie.levenez@yole.fr
+49 15 123 544 182

Benelux, UK & Spain

Marine Wybranietz - marine.wybranietz@yole.fr
+49 69 96 21 76 78

HEADQUARTER & CUSTOM PROJECT SERVICES

22 Bd Benoni Goullin
44200 Nantes, France
sales@systemplus.fr - +33 2 40 18 09 16

India and RoA

Takashi Onozawa - takashi.onozawa@yole.fr
+81 80 4371 4887

Greater China

Mavis Wang - mavis.wang@yole.fr
+886 979 336 809 +86 136 6156 6824

Korea

Peter Ok - peter.ok@yole.fr
+82 10 4089 0233

Japan

Miho Ohtake - miho.ohtake@yole.fr
+81 34 4059 204

Japan and Singapore

Itsuyo Oshiba - itsuyo.oshiba@yole.fr
+81 80 3577 3042

Japan

Toru Hosaka - toru.hosaka@yole.fr
+81 90 1775 3866

REPORTS & MONITORS WEBSITE

www.systemplus.fr

TRACKS WEBSITE

www.reverse-costing.com

MARKETING, COMMUNICATION & PR

Camille Veyrier, Marketing & Communication
camille.veyrier@yole.fr - +33 472 83 01 01

Sandrine Leroy, Public Relations
sandrine.leroy@yole.fr - +33 4 72 83 01 89

Follow us on

